

Section 3 - Carrier Angles

180°

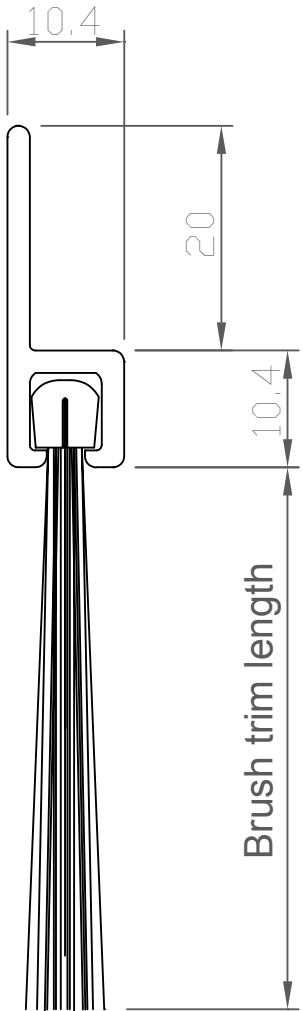

45°

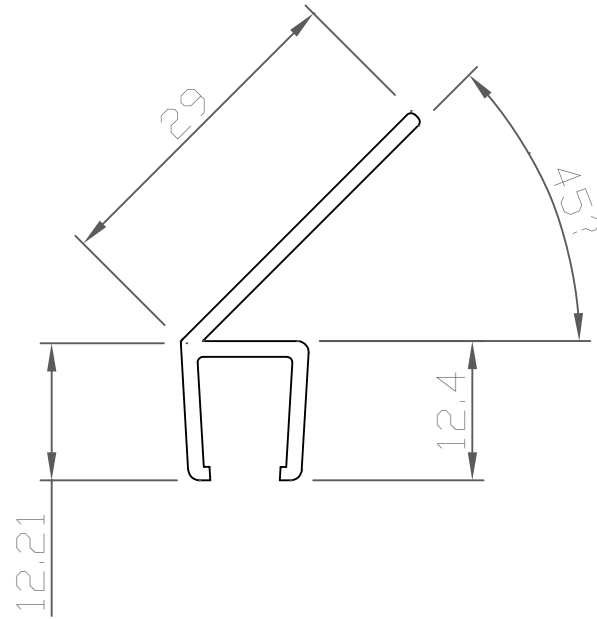

90°

