

Section 4 - Carrier Angles

180°

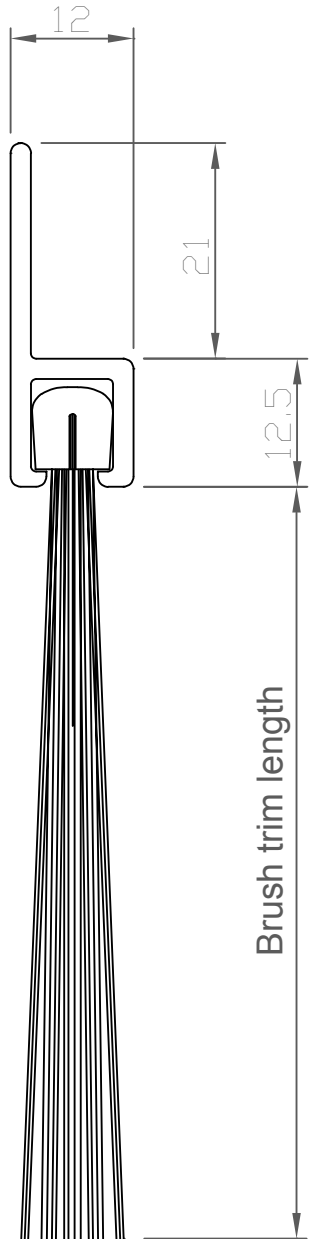

45°

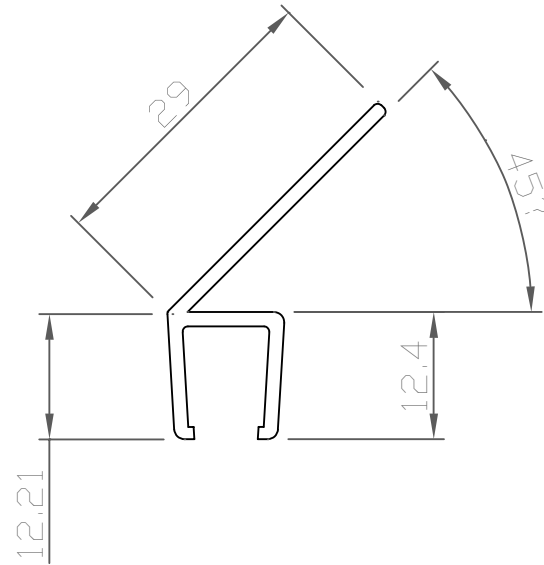

90°

